

# 3500 series

## High performance toggle switches - environmentally sealed

*Distinctive features and specifications*

UG1410A

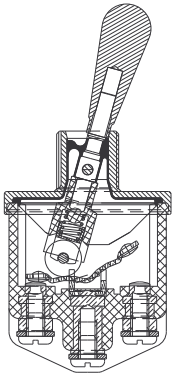

- Completely sealed switches withstanding 0,1 bar pressure**
  - Frontal sealing to IP67 or IP69K by a silicone membrane (for sealed panel mounting, add washer U60, section I).
  - Rear sealing to IP 64 provided by moulded-in terminal inserts
- Approved to European standards CECC 96000**
- Three types of terminals**
- Many lever styles available**

### ELECTRICAL SPECIFICATIONS

- Max. current/voltage rating with resistive load and electrical life at full load: see table below
- Initial contact resistance : 10 mΩ max. at 1A 2VDC
- Insulation resistance : 1.000 MΩ
- Dielectric strength : 2.500 Vrms 50 Hz min. between terminals  
3.000 Vrms 50 Hz min. between terminals and frame

FUNCTIONS	GENERAL PERFORMANCES
ON-OFF et ON-ON	10.000 cycles, T20°C 15A 28VDC resistive 15A 28VDC inductive 5A 28VDC lamp
ON OFF ON	10.000 cycles, T20°C 15A 28VDC resistive 15A 28VDC inductive 5A 28VDC lamp
AUTRES FONCTIONS	10.000 cycles, T20°C 15A 28VDC resistive 10A 28VDC inductive 3A 28VDC lamp

### MATERIALS

- Case : mineral filled polyester UL94-V0
- Bushing and cover : zamac
- Actuator : brass, nickel or chrome plated, or anodized aluminium
- Contacts : silver alloy

### AGENCY APPROVAL



CECC 96201-004

**Availability** : consult factory for details of approved models.

**Marking** : to order switches marked CECC, complete appropriate box of ordering format.

### GENERAL SPECIFICATIONS

- Mechanical life : 40.000 cycles
- Torque : 2 Nm (1.47 Ft.lb) max. applied to nut
- Panel thickness : see "Mounting Accessories" on the following pages
- Operating temperature : -40°C to +85°C
- Moisture resistance : 56 days

The company reserves the right to change specifications without notice.

# 3500 series

## High performance toggle switches - environmentally sealed

Overview

MODEL  
STRUCTURE

35

SERIES

### Number of poles

- 3 Single pole
- 4 Double pole

### Electrical functions

1-0	ON	-	OFF
2-0	ON	-	m.OFF
3-0	OFF	-	MOM
4-1	ON	<sup>3</sup> ON <sup>4</sup>	ON▲
4-2	ON	<sup>3</sup> ON <sup>4</sup>	MOM▲
4-3	MOM	<sup>3</sup> ON <sup>4</sup>	MOM▲
4-4	ON	<sup>1</sup> ON <sup>6</sup>	ON▲
4-5	ON	<sup>1</sup> ON <sup>6</sup>	MOM▲

### Electrical functions (continued)

4-6	MOM	<sup>1</sup> ON <sup>6</sup>	MOM▲
5-0	ON	-	MOM
6-0	ON	-	ON
7-0	MOM	OFF	MOM
8-0	ON	OFF	MOM
9-0	ON	OFF	ON

▲ Function 4 : double pole only

### Terminals

- 0 Screw
- 2 Solder lug/quick-connect
- 3 Normalized quick-connect
- 4 Screw + clamp

OPTIONS

### Lever styles

- 1 Standard, length 17,5 mm (.688) or locking, length 20 mm (.787)
- 2 Length 30 mm (1.181)
- 3 Flatted, length 24 mm (.944)
- 4 Length 40 mm (1,574)
- 5 Length 50 mm (1.968)
- 6 Locking, length 25,4 mm (1.000)

### Lever locking styles

- 0 No locking
  - A Locked in 3 positions
  - D Locked out of center position
  - G Locked in keyway side
- See drawings on the following pages.

### Accessories

- 0 2 hex nuts, 1 locking ring and 1 lockwasher
- 2 2 hex nuts and 1 sealing washer

### Lever finish

- N Bright nickel
  - B Satin chrome
  - G\* Black
  - F\* Black with fluorescent tip (lever type 1 only)
  - C Painted or anodized
- \* Black finish on bushing too.

### Agency approval

- 0 None
- 1 CECC

### Locking lever special finish

- (blank) None
  - P5 Painted yellow
  - A6 Anodized red
- Order with lever finish type C.  
Other colours : on request.



**NOTICE :** please note that not all combinations of above numbers are available. Refer to the following pages for further information.

### ABOUT THIS SERIES

On the following pages, you will find successively :

- model structure of switches
- their options in the same order as in above chart

**Dimensions :** first dimensions are in mm while inches are shown as bracketed numbers.

**Security caps** are available to prevent inadvertent lever operation. They are presented in section I.



**Packaging unit :** 25 pieces

# 3500 series

High performance toggle switches - environmentally sealed

MODEL  
STRUCTURE

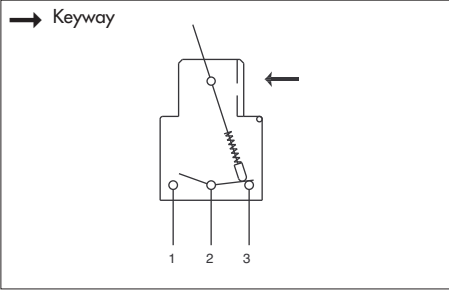

- Screw, solder lug or quick-connect terminals
- Also available with threaded terminals : consult factory
- Screw terminals + clamp : on request.

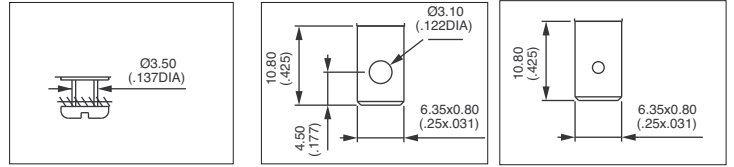

A

## MODEL STRUCTURE

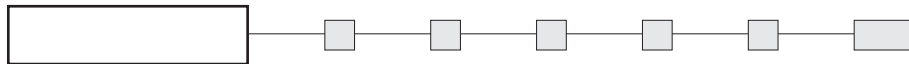

Shown with standard lever



FUNCTIONS			BASIC PART NUMBER					
III	II	I	Screw terminals		Solder lugs and quick-connect term.		Normalized quick-connect terminals	
A2-A3	* A3-B5	A1-A2	Single pole	Double pole	Single pole	Double pole	Single pole	Double pole
B5-B6	** A1-B5	B5-B4						
ON	-	OFF	3531-00	3541-00	3531-02	3541-02	3531-03	3541-03
ON	-	m.OFF	3532-00	3542-00	3532-02	3542-02	3532-03	3542-03
OFF	-	MOM	3533-00	3543-00	3533-02	3543-02	3533-03	3543-03
ON	ON *	ON		3544-10		3544-12		3544-13
ON	ON *	MOM		3544-20		3544-22		3544-23
MOM	ON *	MOM		3544-30		3544-32		3544-33
ON	ON **	ON		3544-40		3544-42		3544-43
ON	ON **	MOM		3544-50		3544-52		3544-53
MOM	ON **	MOM		3544-60		3544-62		3544-63
ON	-	MOM	3535-00	3545-00	3535-02	3545-02	3535-03	3545-03
ON	-	ON	3536-00	3546-00	3536-02	3546-02	3536-03	3546-03
MOM	OFF	MOM	3537-00	3547-00	3537-02	3547-02	3537-03	3547-03
ON	OFF	MOM	3538-00	3548-00	3538-02	3548-02	3538-03	3548-03
ON	OFF	ON	3539-00	3549-00	3539-02	3549-02	3539-03	3549-03

→ Keyway

\* and \*\*: A2-B4 and A2-B6 = jumper to be wired by the user.

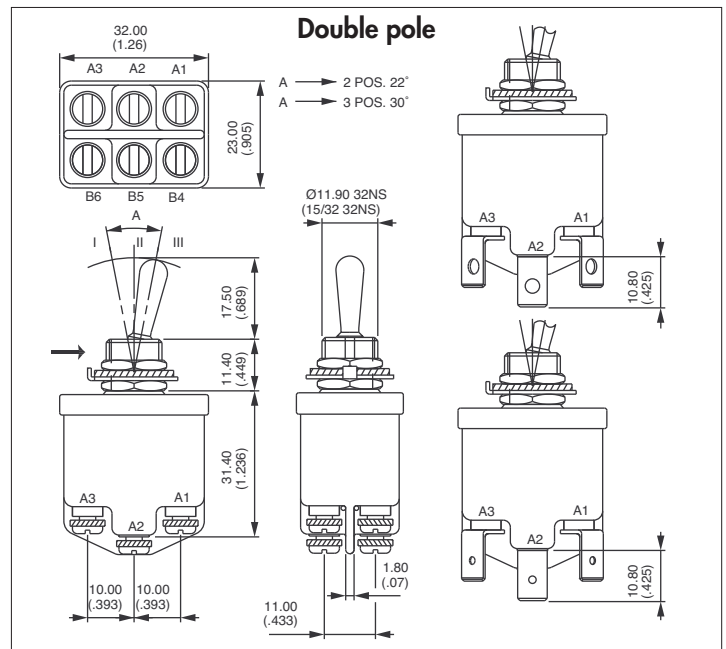
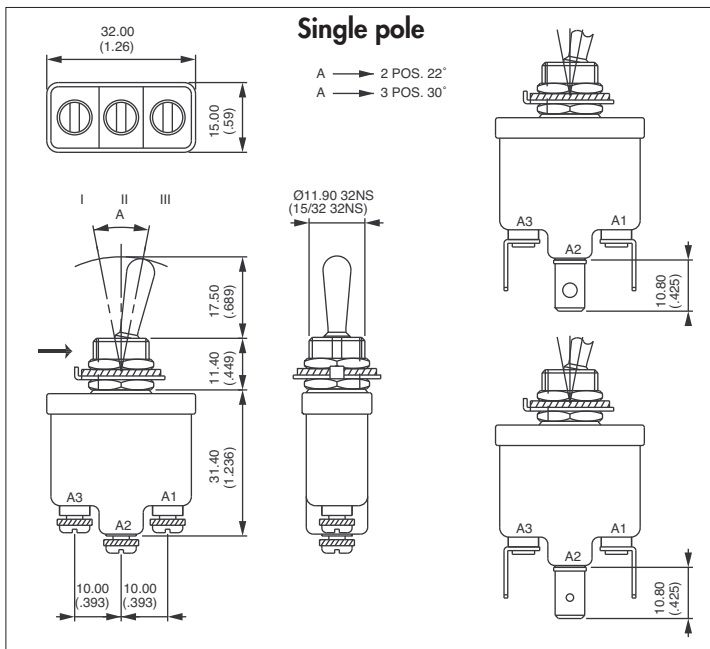



# 3500 series

High performance toggle switches - environmentally sealed

## LEVER STYLES

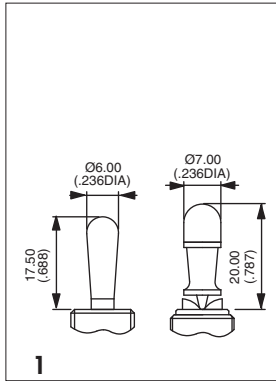
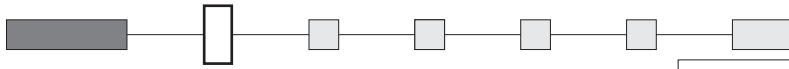

1

Standard

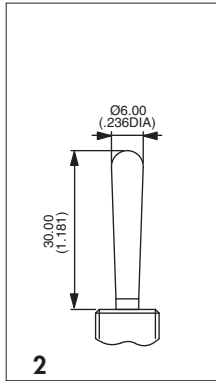

2

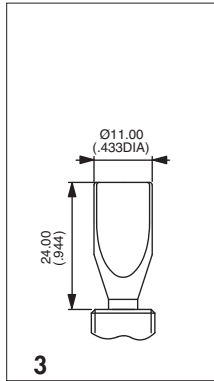

3

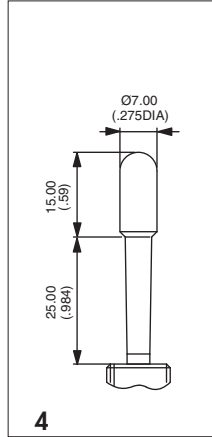

4

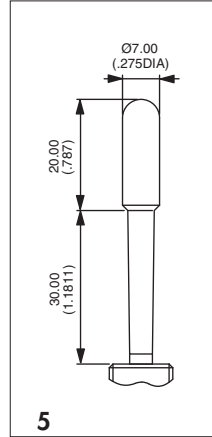

5

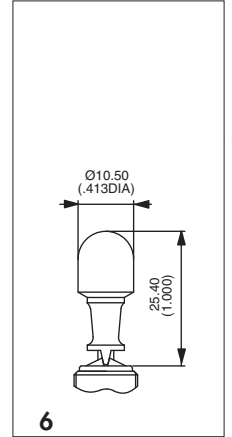

6

## LEVER FINISH

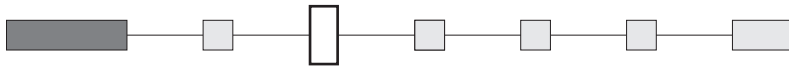

- N Bright nickel
- B Satin chrome
- G\* Black
- F\* Black with fluorescent tip (available with lever type 1 only)
- C Painted or anodized (for locking lever only)

\* Black finish on bushing too.

## LOCKING LEVER STYLES

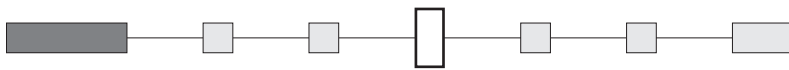

0 No locking

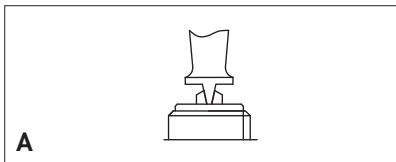
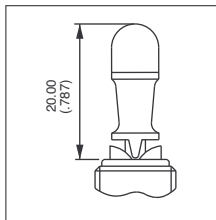

A Locked in 3 positions.  
For functions 4-1, 4-4 and 9-0.

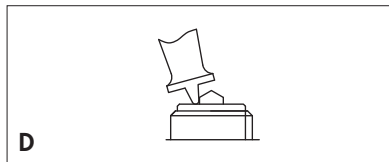

D Locked out of center position.  
For functions 1-0 and 6-0.

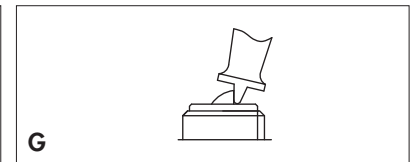

G Locked in keyway.  
For functions 1-0 and 6-0.

# 3500 series

High performance toggle switches - environmentally sealed

OPTIONS  
● ● ●

## AGENCY APPROVAL

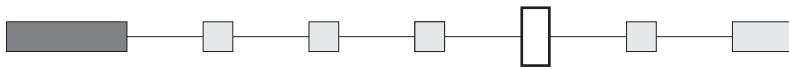

- 0 None
- 1 CECC

A

## MOUNTING ACCESSORIES

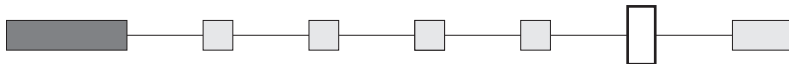

- 0 For NON-SEALED mounting (panel cut-out fig. 1, 2 or 3)  
2 hex nuts 14 mm (.551) across flats, 1 locking ring U121 or U12, 1 lockwasher U13  
Panel thickness : 5 mm (.196) max.
- 2 For SEALED mounting (panel cut-out fig. 2)  
2 hex nuts 14 mm (.551) across flats and 1 sealing washer U60  
Panel thickness : 4 mm (.157) max.

**Special hardware** : black cap nut U129. Order separately. See section I.

### PANEL CUT-OUT

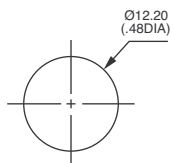

Figure 1

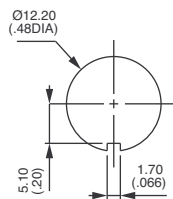

Figure 2

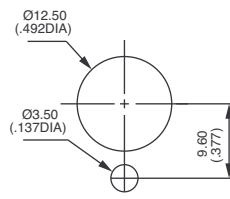
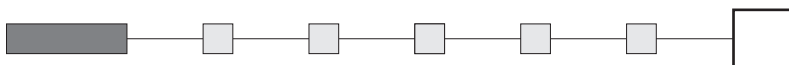

Figure 3

## LOCKING LEVER SPECIAL FINISH



- (blank) None
- P5 Painted yellow
- A6 Anodized red

Order with lever finish type C.  
Other colours on request.